

LED Flood Light

XLT-300W

170LM/W

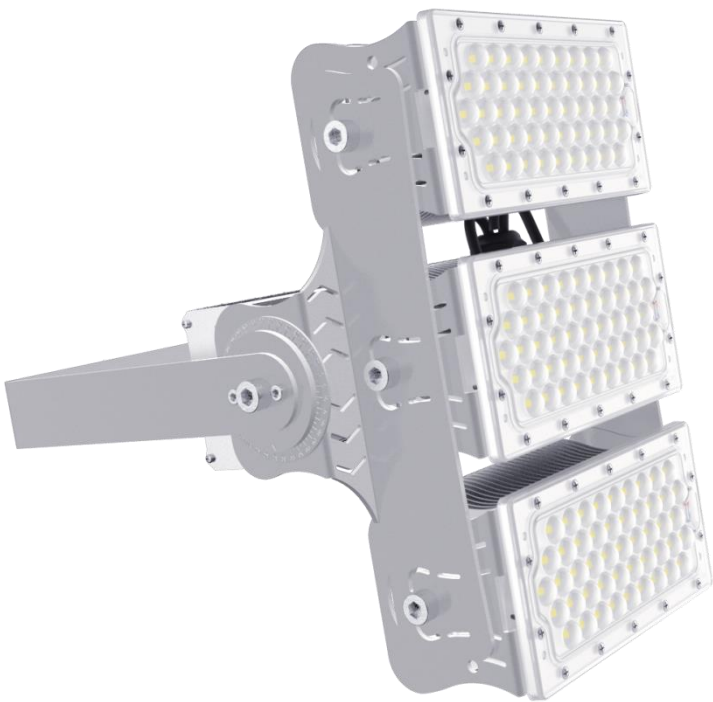



Features:

- High lumen
- Replaceable lens
- Adjustable module
- Aluminium cooling fin
- IP Grade: IP66

Areas of application:

Garages / Public area / Factory / Warehouse / Stadium/
Sports ground / etc.

	Energy saving up to 80%
---	--------------------------------------

	Long service life 50000 hrs
---	---------------------------------------

	Maintenance long life Free
---	---



1 Parameter



Wattage	CRI	Power Factor
300W	Ra>70	>0.95
Operating Temp.	IP Grade	Luminous Flux
-40°C ~+60°C	IP66	51,000LM
Beam Angle	Rated Voltage	
10°/ 30° /60° /90°/120°	AC 100-240V 277V~ 50/60Hz	

2 Beam angle

Multiple angles are available.

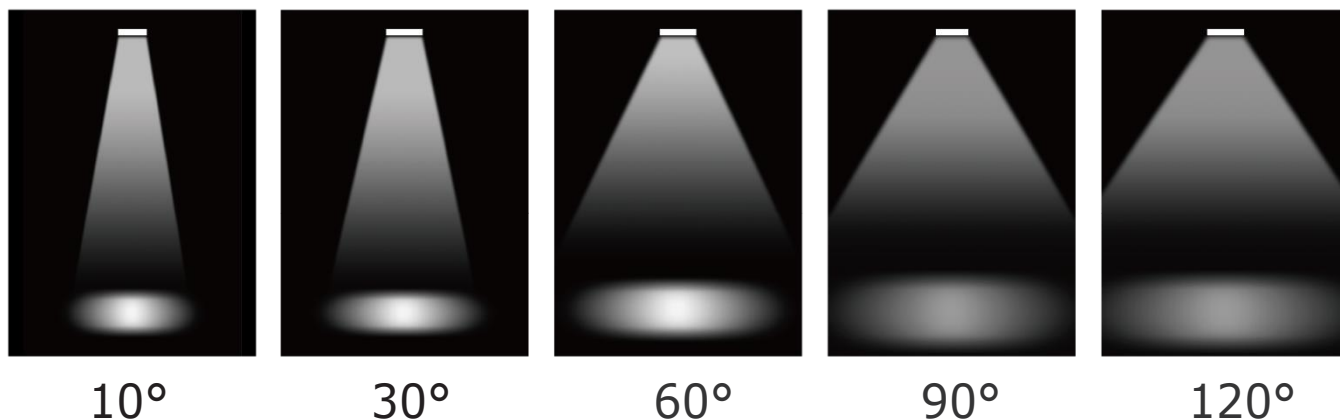

10°

30°

60°

90°

120°

3 Installation

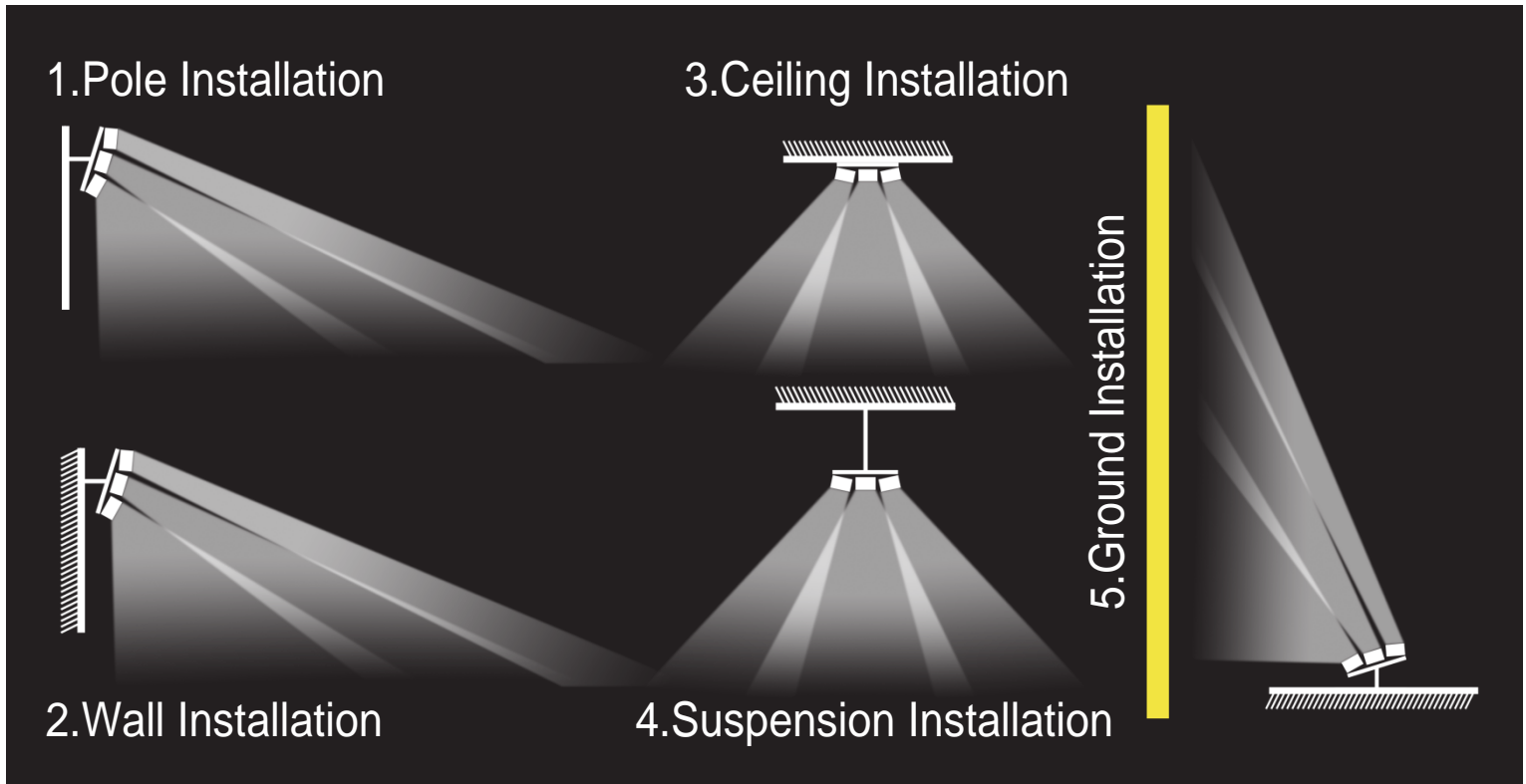

4 Dimensions

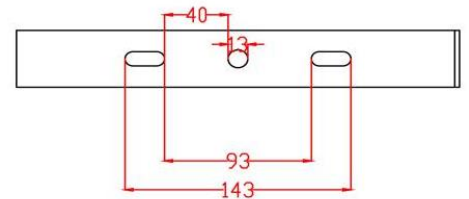
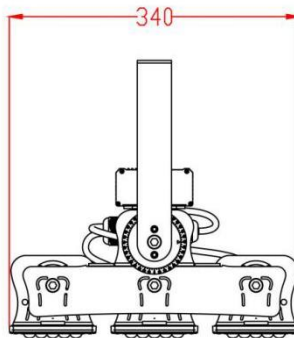
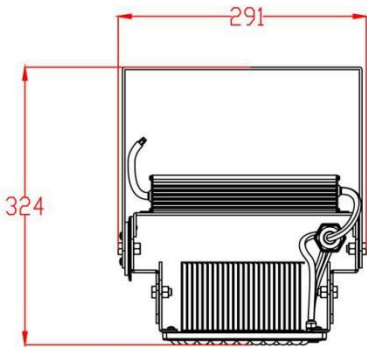

5 Packaging

Net weight	Size of Box	Weight of Box
5.6KG	41*34*23 CM	6.7 KG