

**XLT-600W**

**170LM/W**

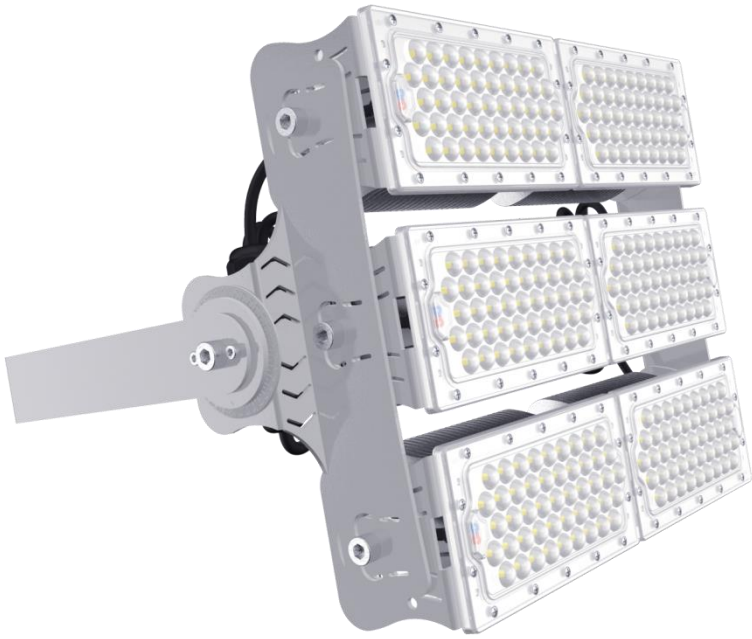

## Features:

- High lumen
- Replaceable lens
- Adjustable module
- Aluminium cooling fin
- IP Grade: IP66

## Areas of application:

Sports field / Industrial site / Harbor / Stadium / Factory / Horse arena / Parking area etc.

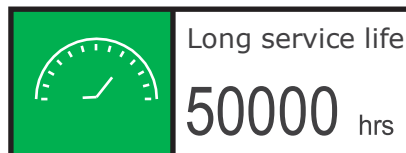
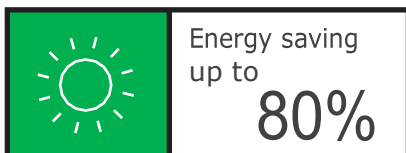

# 1 Parameter

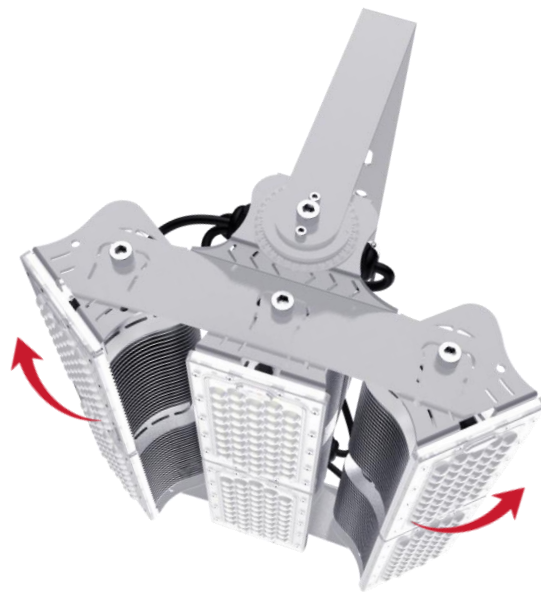

Wattage	CRI	Power Factor
600W	Ra>80	>0.95
Operating Temp.	IP Grade	Luminous Flux
-40°C ~ +60°C	IP66	102,000LM
Beam Angle	Rated Voltage	
10°/ 30° /60° /90°/120°	AC 100-240V 277V~ 50/60Hz	

# 2 Beam angle

Multiple angles are available.

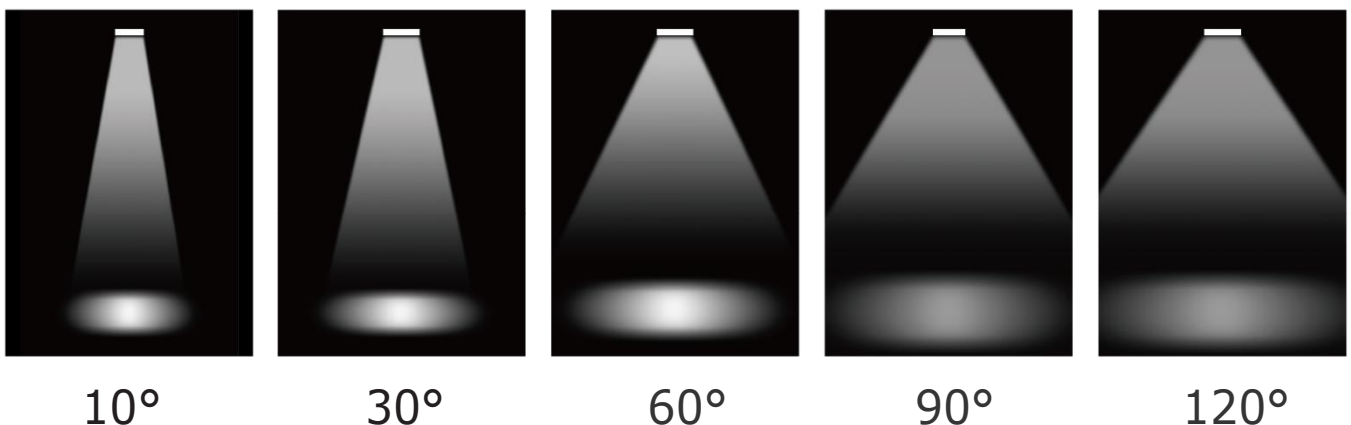

### 3 Installation

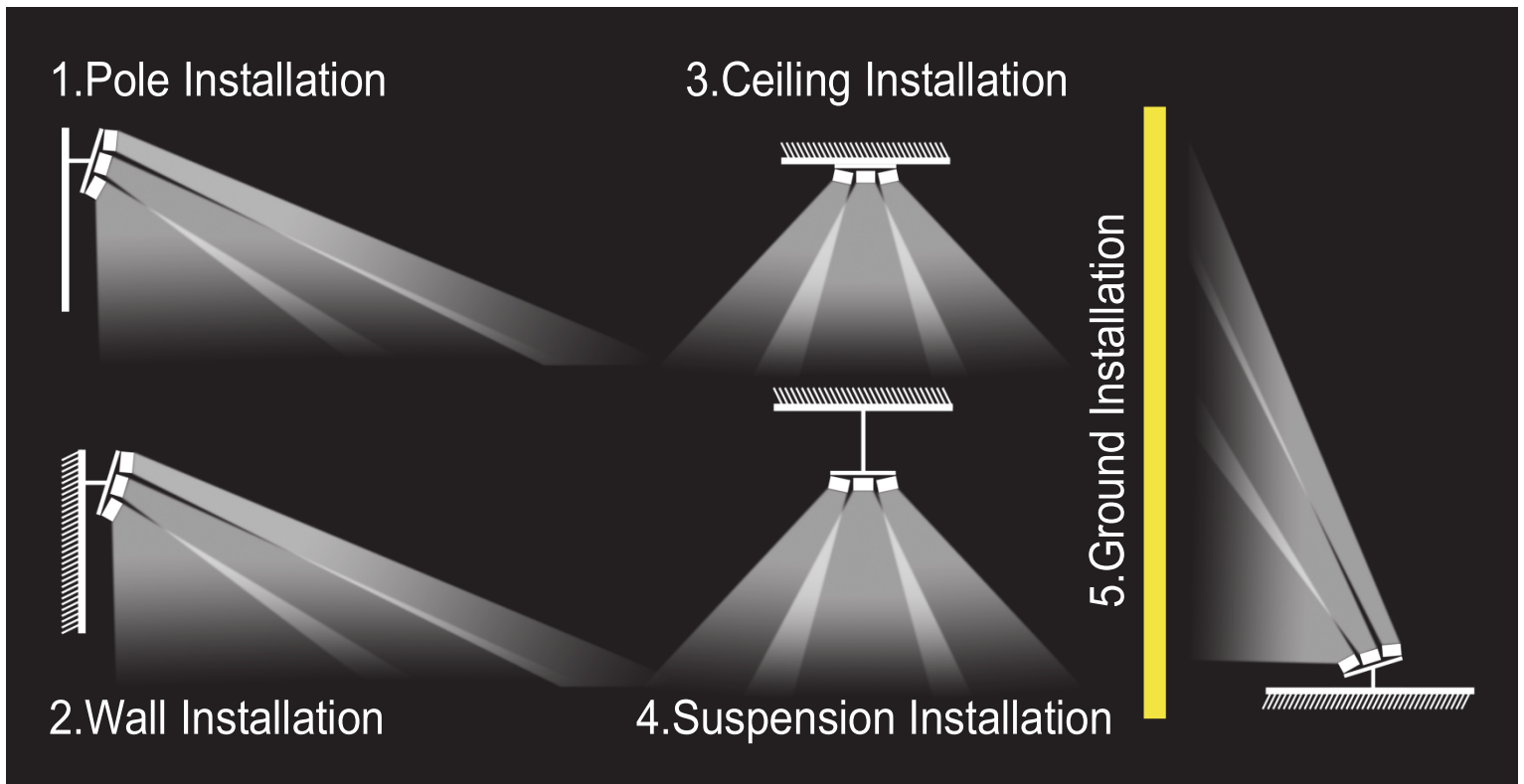

### 4 Dimensions

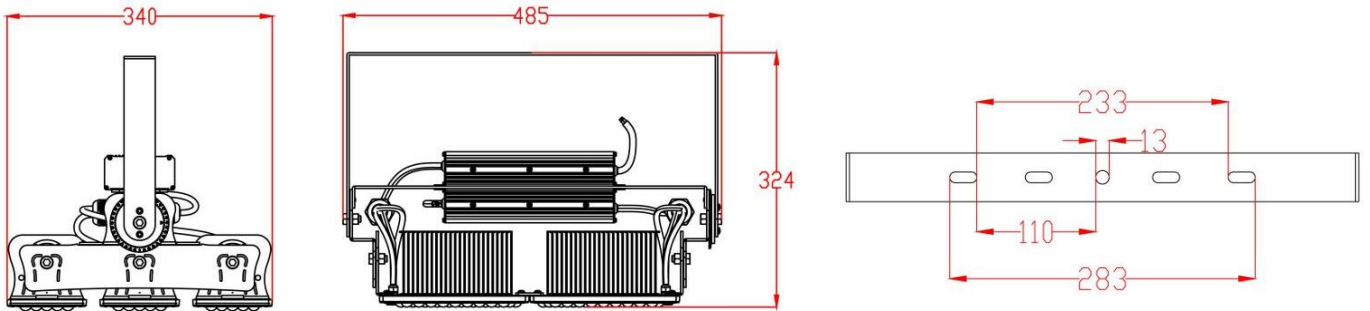

### 5 Packaging

Net weight	Size of box	Weight of box
10.3KG	54*42*25 CM	10.9KG