

ULTRA-LUX 240W 180 LM/W





Features:

- High lumen
- Easy combination
- Adjustable module
- IP66 & IK10

Areas of application:

Large stadiums, Airports, Parking lots, Terminals, Tennis court, Golf course, Power stations, Commercial parks etc.

	Energy saving up to 80%
---	--------------------------------------

	Long service life 50000 hrs
---	---------------------------------------

	Maintenance long life Free
---	---

1 Parameter



Wattage	CRI	Power Factor
240W	Ra>80	>0.95
Operating Temp	IP & IK Grade	Luminous Flux
-40°C ~55°C	IP66 & IK10	43,200LM
Beam Angle	Rated Voltage	
30°/60°/90° Asymmetric G4	AC 100-240V 277V~, 50/60Hz	

2 Beam angle



30°



60°



90°



Asymmetric G4

3 Installation

① Ground Installation

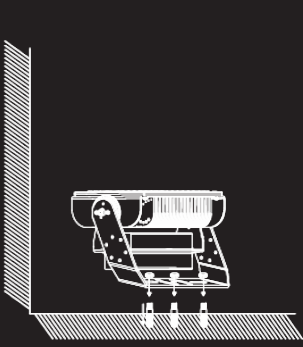

② Wall Installation

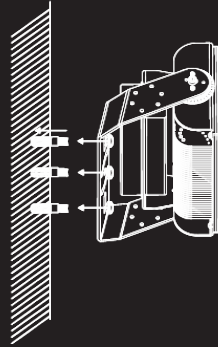

③ Pole Installation

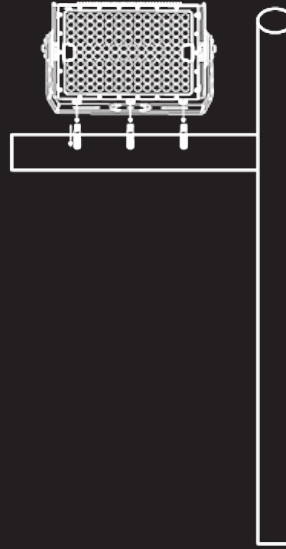

④ Ceiling Installation

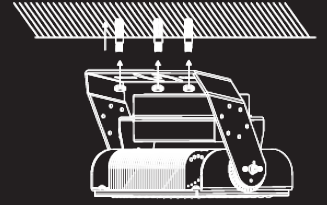

4 Dimensions

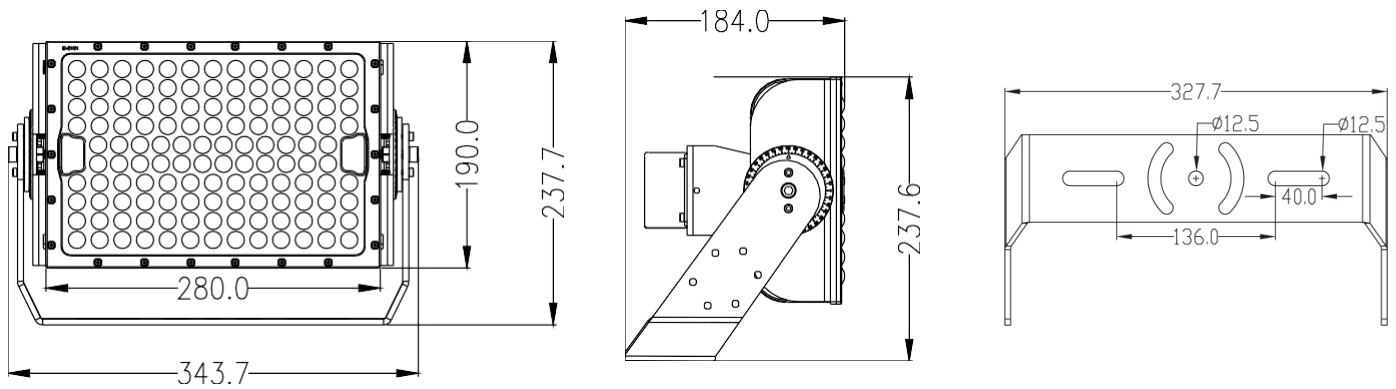

5 Packaging

Net weight	Size of box	Weight of box
5.5 KG	39*29.5*23.5 CM	6.0 KG